

FAB50RCR5



Product Family	Refrigerator
Installation	Free standing
Category	Top Mount
Reference width	70 - 80
Cooling type	Total No Frost - Double Cooling system
Defrost	Automatic
Hinge type	Standard
Hinge position	Right
EAN code	8017709299392



Aesthetics



Aesthetic	50's Style	Side material	Steel
Colour	Cream	Side colour	Cream
Finishing	Glossy	Logo	Applied
Design	Rounded	Door shelves profile color	Silver
Material	Heat-moulded	Drawers profile color	Silver
Handle	External	Color of glass shelf profile	Chrome
Handle type	Fixed	Display	LED
Handle colour	Chrome	Display position	Interno (cella frigo)
Logo colour	Chrome		

Refrigerator compartment features



No. of adjustable shelves	2	Type of crisper/vegetable drawers cover	Glass
Number of fruit and vegetables drawers	1	Life Plus zone-0°C	Yes
Type of adjustable shelves	Glass	Internal light in fridge	Yes
Type of crisper/vegetable drawers cover	Standard	Type of internal light (fridge)	LED
Crisper Cover	Yes		

Refrigerator Inner Door

Number of adjustable door shelves	3	No. of bottle shelves	1
--	---	------------------------------	---

Other Refrigerator features



MultiFlow	Yes	Ionizer	Yes
Fan	Yes		

Freezer compartment features

No. of shelves	1	Type of internal light (freezer)	LED
Internal light in freezer	Yes	Type of shelves	Glass

Freezer Inner Door

No. of adjustable door shelves	2
---------------------------------------	---

Other Freezer features



Manual ice maker	Yes	Fast freezing compartment	Yes
Ice maker	Manual		

Other technical features



Functions display	Fast freezing, ECO, Temperature alarm
Fast freezing button	Yes
Door open alarm	Acoustic and visual
Type of temperature control	Electronic
No. of compressors	1
Refrigerant gas type	R600a
Type of compressor	Inverter
Refrigerant Quantity (gr)	62 g
Foam agent	Cyclopentane

Performance / Energy Label NEW 2019



Annual energy consumption	265 kWh/a	Airborne acoustical noise emissions	41 dB(A) re 1pW
Energy efficiency class	E	Temperature Rise Time	15 h







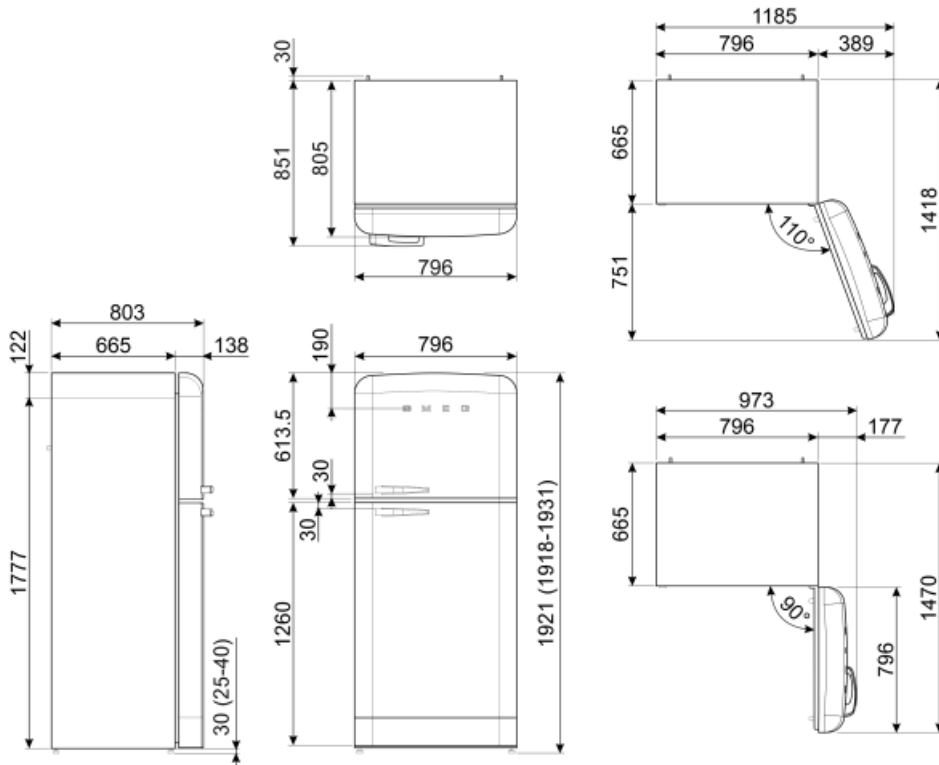





Airborne acoustical noise emission class	C	4 star - Freezing capacity	8 Kg/24h
Total net volume	524 l	Climate class	SN, N, ST, T
Sum of the volumes of the frozen compartment(s)	124 l	EI	96 %
Sum of the volumes of the chill compartment(s) and the unfrozen compartment(s)	400 l		

Electrical Connection

Plug	(F;E) Schuko	Voltage (V)	220-240 V
Electrical connection rating	197 W	Frequency (Hz)	50/60 Hz
Current	1.1 A	Power supply cable length	180 cm



Symbols glossary (TT)

 <p>4 stars freezing compartment for better food preservation.</p>	 <p>A++: Energy efficiency class A++ helps to save up to 20% energy compared to class A. Maximum performance with minimum consumption is guaranteed.</p>
 <p>Smeg Active Ion system improves the quality of the air inside the cell. Thanks to the generation of negatively charged ions released inside the fridge Active Ion system neutralizes unpleasant dust.</p>	 <p>The automatic defrost system works by automatically defrosting at regular intervals eliminating the need to defrost altogether.</p>
 <p>LED display: to show programmes, functions and options selected and the time to the end of the cycle.</p>	 <p>Economical mode: Analyzes fridge functioning during the activation and optimizes the operating cycle in order to reduce power consumption.</p>
 <p>Ventilated: Forced distribution of cold air in the refrigerator compartment, which allows even temperature distribution within the fridge.</p>	 <p>Fast freezing: The fast freezing function brings the temperature of the compartment down when activated a few hours prior to usage.</p>
 <p>LED interior lighting: is a more energy efficient and long lasting way of illuminating the interior of the appliance.</p>	 <p>Life Plus 0°C: The temperature in the Lifeplus compartments is kept at 0°C, which preserves fresh meat and fish longer.</p>
 <p>Smeg's evolution towards more intelligent and eco-friendly models has led to the choice of Inverter technology, which significantly reduces consumption.</p>	 <p>Air plus: keeps food fresher for longer.</p>
 <p>Energy efficiency class E</p>	