

FAB32LPG5



Product Family	Refrigerator
Installation	Free standing
Category	Bottom Mount
Reference width	Until 60
Sistema Total No - Frost	Total
Cooling type	Total No Frost - Double Cooling system
Defrost	Automatic
Hinge type	Standard
Hinge position	Left
EAN code	8017709298067



Aesthetics



Aesthetic	50's Style	Side material	Steel
Colour	Pastel green	Side colour	Pastel green
Finishing	Glossy	Logo	Applied
Design	Rounded	Door shelves profile color	Chrome
Material	Heat-moulded	Drawers profile color	Chrome
Handle	External	Color of glass shelf profile	Chrome
Handle type	Fixed	Display	LED
Handle colour	Chrome	Display position	Interno (sul Top)
Logo colour	Chrome	Alternative colours available	Orange, Pastel blue, White, Blue, Black, Cream, Pink, Red, Silver, Pastel green, Lime green

Refrigerator compartment features



No. of adjustable shelves	2	Type of crisper/vegetable drawers cover	Glass
Number of fruit and vegetables drawers	1	Life Plus zone-0°C	-2°C +3 °C
Type of adjustable shelves	Glass	Internal light in fridge	Yes
		Type of internal light (fridge)	LED

Type of crisper/vegetable drawers cover On sliding rails

Crisper Cover Yes

Refrigerator Inner Door

No. of door shelves with transparent cover 1

Number of adjustable door shelves 2

Adjustable door shelves with wire support Yes

No. of bottle shelves 1

Bottle shelves with wire support Yes

Other Refrigerator features



MultiFlow Yes

Fan Yes

Freezer compartment features

Number of drawers 3

No. of shelves 2

Type of shelves Glass

Other Freezer features



Fast freezing compartment Yes

Other technical features



Functions display

Holiday, Fast freezing, Fast cooling, ECO, Temperature alarm

Fast freezing button

Yes

Power on lamp

Yes

Temperature alarm lamp

Yes

Door open alarm

Acoustic and visual

Temperature Alarm

Yes

Type of temperature control

Electronic

No. of compressors

1

Refrigerant gas type

R600a

Type of compressor

Inverter

Refrigerant Quantity (gr)

60 g

Foam agent

Cyclopentane

Performance / Energy Label NEW 2019



Annual energy consumption	204 kWh/a	Airborne acoustical noise emissions	37 dB(A) re 1pW
Energy efficiency class	D	Temperature Rise Time	40 h
Airborne acoustical noise emission class	C	4 star - Freezing capacity	6 Kg/24h
Total net volume	331 l	Climate class	SN, N, ST, T
Sum of the volumes of the frozen compartment(s)	97 l	EEL	80 %
Sum of the volumes of the chill compartment(s) and the unfrozen compartment(s)	234 l		

Electrical Connection

Plug	(F;E) Schuko	Voltage (V)	220-240 V
Electrical connection rating	127 W	Frequency (Hz)	50/60 Hz
Current	0.8 A	Power supply cable length	180 cm

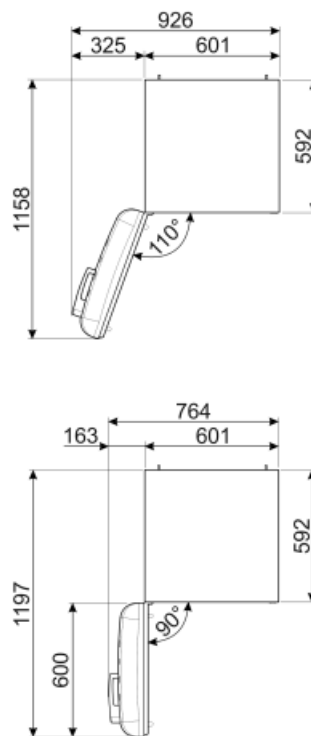
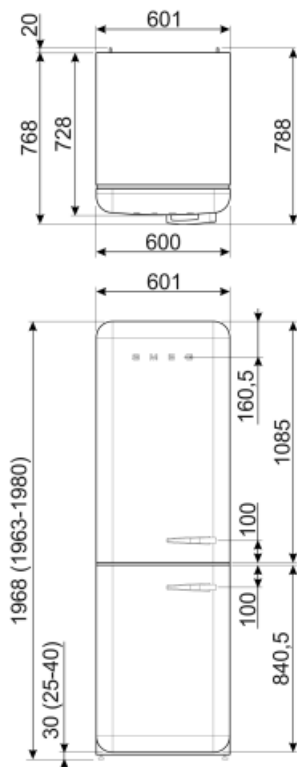

Alternative products



FAB32LRD5

Hinge position: Left
Red



FAB32RLI5

Hinge position: Right
Lime green



FAB32RBL5

Hinge position: Right
Black



FAB32LPB5

Hinge position: Left
Pastel blue



FAB32RSV5

Hinge position: Right
Silver



FAB32LCR5

Hinge position: Left
Cream



FAB32RCR5

Hinge position: Right
Cream



FAB32LSV5

Hinge position: Left
Silver



FAB32RPB5

Hinge position: Right
Pastel blue



FAB32RRD5

Hinge position: Right
Red



FAB32LPK5

Hinge position: Left
Pink



FAB32LWH5

Hinge position: Left
White



FAB32LBL5

Hinge position: Left
Black



FAB32RPK5

Hinge position: Right
Pink



FAB32RWH5

Hinge position: Right
White



FAB32RPG5

Hinge position: Right
Pastel green



FAB32RBE5

Hinge position: Right
Blue



FAB32LOR5













Hinge position: Left
Orange



FAB32ROR5

Hinge position: Right
Orange

Symbols glossary (TT)

 <p>4 stars freezing compartment for better food preservation.</p>	 <p>The automatic defrost system works by automatically defrosting at regular intervals eliminating the need to defrost altogether.</p>
 <p>LED display: to show programmes, functions and options selected and the time to the end of the cycle.</p>	 <p>Economical mode: Analyzes fridge functioning during the activation and optimizes the operating cycle in order to reduce power consumption.</p>
 <p>Energy efficiency class D</p>	 <p>A+++: Appliances with this symbol can reduce energy consumption by a further 30% from the standard A energy rating.</p>
 <p>Ventilated: Forced distribution of cold air in the refrigerator compartment, which allows even temperature distribution within the fridge.</p>	 <p>Fast freezing: The fast freezing function brings the temperature of the compartment down when activated a few hours prior to usage.</p>
 <p>Power saving mode: The power saving mode allows you to disable the refrigerator and keep the freezer working.</p>	 <p>LED interior lighting: is a more energy efficient and long lasting way of illuminating the interior of the appliance.</p>
 <p>Life Plus 0°C: The temperature in the Lifepius compartments is kept at 0°C, which preserves fresh meat and fish longer.</p>	 <p>Smeg's evolution towards more intelligent and eco-friendly models has led to the choice of Inverter technology, which significantly reduces consumption.</p>
 <p>Air plus: keeps food fresher for longer.</p>	