

# FAB32LCR5



<b>Product Family</b>	Refrigerator
<b>Installation</b>	Free standing
<b>Category</b>	Bottom Mount
<b>Reference width</b>	Until 60
<b>Sistema Total No - Frost</b>	Total
<b>Cooling type</b>	Total No Frost - Double Cooling system
<b>Defrost</b>	Automatic
<b>Hinge type</b>	Standard
<b>Hinge position</b>	Left
<b>EAN code</b>	8017709298036



## Aesthetics



<b>Aesthetic</b>	50's Style	<b>Side material</b>	Steel
<b>Colour</b>	Cream	<b>Side colour</b>	Cream
<b>Finishing</b>	Glossy	<b>Logo</b>	Applied
<b>Design</b>	Rounded	<b>Door shelves profile color</b>	Chrome
<b>Material</b>	Heat-moulded	<b>Drawers profile color</b>	Chrome
<b>Handle</b>	External	<b>Color of glass shelf profile</b>	Chrome
<b>Handle type</b>	Fixed	<b>Display</b>	LED
<b>Handle colour</b>	Chrome	<b>Display position</b>	Interno (sul Top)
<b>Logo colour</b>	Chrome	<b>Alternative colours available</b>	Orange, Pastel blue, White, Blue, Black, Cream, Pink, Red, Silver, Pastel green, Lime green

## Refrigerator compartment features



<b>No. of adjustable shelves</b>	2	<b>Type of crisper/vegetable drawers cover</b>	Glass
<b>Number of fruit and vegetables drawers</b>	1	<b>Life Plus zone-0°C</b>	-2°C +3 °C
<b>Type of adjustable shelves</b>	Glass	<b>Internal light in fridge</b>	Yes
		<b>Type of internal light (fridge)</b>	LED

Type of crisper/vegetable drawers cover On sliding rails

Crisper Cover Yes

## Refrigerator Inner Door

No. of door shelves with transparent cover 1

Number of adjustable door shelves 2

Adjustable door shelves with wire support Yes

No. of bottle shelves 1

Bottle shelves with wire support Yes

## Other Refrigerator features



MultiFlow Yes

Fan Yes

## Freezer compartment features

Number of drawers 3

No. of shelves 2

Type of shelves Glass

## Other Freezer features



Fast freezing compartment Yes

## Other technical features



Functions display

Holiday, Fast freezing, Fast cooling, ECO, Temperature alarm

Fast freezing button

Yes

Power on lamp

Yes

Temperature alarm lamp

Yes

Door open alarm

Acoustic and visual

Temperature Alarm

Yes

Type of temperature control

Electronic

No. of compressors

1

Refrigerant gas type

R600a

Type of compressor

Inverter

Refrigerant Quantity (gr)

60 g

Foam agent

Cyclopentane

## Performance / Energy Label NEW 2019



<b>Annual energy consumption</b>	204 kWh/a	<b>Airborne acoustical noise emissions</b>	37 dB(A) re 1pW
<b>Energy efficiency class</b>	D	<b>Temperature Rise Time</b>	40 h
<b>Airborne acoustical noise emission class</b>	C	<b>4 star - Freezing capacity</b>	6 Kg/24h
<b>Total net volume</b>	331 l	<b>Climate class</b>	SN, N, ST, T
<b>Sum of the volumes of the frozen compartment(s)</b>	97 l	<b>EEL</b>	80 %
<b>Sum of the volumes of the chill compartment(s) and the unfrozen compartment(s)</b>	234 l		

## Electrical Connection

<b>Plug</b>	(F;E) Schuko	<b>Voltage (V)</b>	220-240 V
<b>Electrical connection rating</b>	127 W	<b>Frequency (Hz)</b>	50/60 Hz
<b>Current</b>	0.8 A	<b>Power supply cable length</b>	180 cm

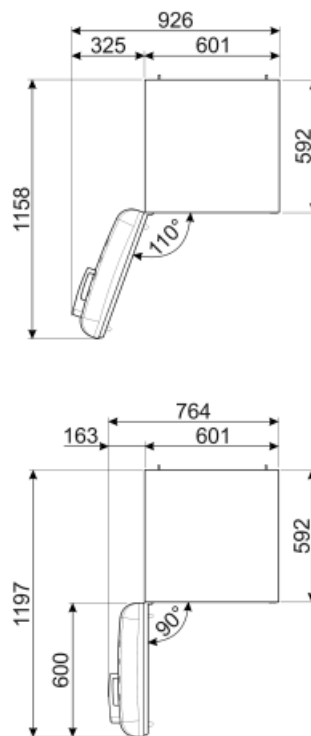
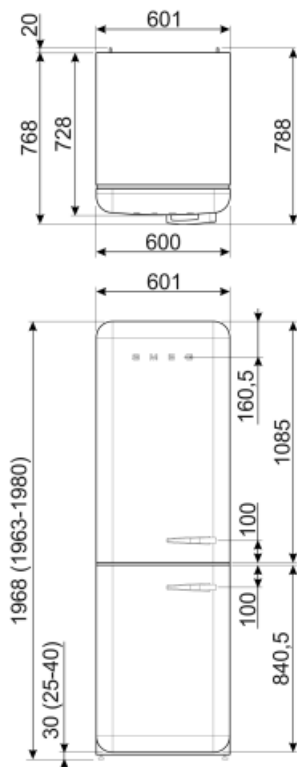

## Alternative products



**FAB32LRD5**

**Hinge position:** Left  
Red



**FAB32RRD5**

**Hinge position:** Right  
Red



**FAB32RLI5**

**Hinge position:** Right  
Lime green



**FAB32LPK5**

**Hinge position:** Left  
Pink



**FAB32RBL5**

**Hinge position:** Right  
Black



**FAB32LWH5**

**Hinge position:** Left  
White



**FAB32LPG5**

**Hinge position:** Left  
Pastel green



**FAB32LPB5**

**Hinge position:** Left  
Pastel blue



**FAB32LBL5**

**Hinge position:** Left  
Black



**FAB32RSV5**

**Hinge position:** Right  
Silver



**FAB32RPK5**

**Hinge position:** Right  
Pink



**FAB32RWH5**

**Hinge position:** Right  
White



**FAB32RCR5**

**Hinge position:** Right  
Cream



**FAB32RPG5**

**Hinge position:** Right  
Pastel green



**FAB32LSV5**

**Hinge position:** Left  
Silver



**FAB32RBE5**

**Hinge position:** Right  
Blue



**FAB32RPB5**

**Hinge position:** Right  
Pastel blue



**FAB32LOR5**













**Hinge position:** Left  
Orange



**FAB32ROR5**

**Hinge position:** Right  
Orange

## Symbols glossary (TT)

 <p>4 stars freezing compartment for better food preservation.</p>	 <p>The automatic defrost system works by automatically defrosting at regular intervals eliminating the need to defrost altogether.</p>
 <p>LED display: to show programmes, functions and options selected and the time to the end of the cycle.</p>	 <p>Economical mode: Analyzes fridge functioning during the activation and optimizes the operating cycle in order to reduce power consumption.</p>
 <p>Energy efficiency class D</p>	 <p>A+++: Appliances with this symbol can reduce energy consumption by a further 30% from the standard A energy rating.</p>
 <p>Ventilated: Forced distribution of cold air in the refrigerator compartment, which allows even temperature distribution within the fridge.</p>	 <p>Fast freezing: The fast freezing function brings the temperature of the compartment down when activated a few hours prior to usage.</p>
 <p>Power saving mode: The power saving mode allows you to disable the refrigerator and keep the freezer working.</p>	 <p>LED interior lighting: is a more energy efficient and long lasting way of illuminating the interior of the appliance.</p>
 <p>Life Plus 0°C: The temperature in the Lifepius compartments is kept at 0°C, which preserves fresh meat and fish longer.</p>	 <p>Smeg's evolution towards more intelligent and eco-friendly models has led to the choice of Inverter technology, which significantly reduces consumption.</p>
 <p>Air plus: keeps food fresher for longer.</p>	