

FAB28RDMC5



Product Family	Refrigerator
Installation	Free standing
Category	One Door
Reference width	Until 60
Reference height	100 - 160
Cooling type	Fan assisted refrigerator, static freezer
Defrost	Automatic for refrigerator, manual for freezer
Hinge type	Standard
Hinge position	Right
EAN code	8017709299156



Aesthetics

Aesthetic Colour	50's Style	Handle colour	Chrome
Decoration / Special colour	Decorated / Special	Logo colour	Chrome
Finishing	Multicolor	Side material	Steel
Design	Glossy	Side colour	Decorated / Special
Material	Rounded	Logo	Applied
Handle	Heat-moulded	Door shelves profile color	Chrome
Handle type	External	Drawers profile color	Chrome
	Fixed	Color of glass shelf profile	Chrome

Refrigerator compartment features



No. of adjustable shelves	2	Type of crisper/vegetable drawers cover	Glass
Number of fruit and vegetables drawers	1	Life Plus zone-0°C	Yes
Type of adjustable shelves	Glass	Internal light in fridge	Yes
Type of crisper/vegetable drawers cover	On sliding rails	Type of internal light (fridge)	LED
Crisper Cover	Yes		

Refrigerator Inner Door

No. of door shelves with transparent cover	1	No. of bottle shelves	1
Number of adjustable door shelves	1	Bottle shelves with wire support	Yes
Adjustable door shelves with wire support	Yes		

Other Refrigerator features



MultiFlow

Yes

Fan

Yes

Freezer compartment features

Internal freezer compartment Yes

Other technical features



Door open alarm

Acoustic and visual

Antibacterial Gasket

Yes

Type of temperature control

Electronic

No. of compressors

1

Refrigerant gas type

R600a

Type of compressor

Inverter

Refrigerant Quantity (gr)

32 g

Foam agent

Cyclopentane

Performance / Energy Label NEW 2019



Annual energy consumption	130 kWh/a	Airborne acoustical noise emissions	35 dB(A) re 1pW
Energy efficiency class	D	Temperature Rise Time	9 h
Airborne acoustical noise emission class	B	4 star - Freezing capacity	2.6 Kg/24h
Total net volume	270 l	Climate class	SN, N, ST, T
Sum of the volumes of the frozen compartment(s)	26 l	EEL	79 %
Sum of the volumes of the chill compartment(s) and the unfrozen compartment(s)	244 l		

Electrical Connection

Plug	(F;E) Schuko	Voltage (V)	220-240 V
Electrical connection rating	90 W	Frequency (Hz)	50/60 Hz
Current	1 A	Power supply cable length	180 cm

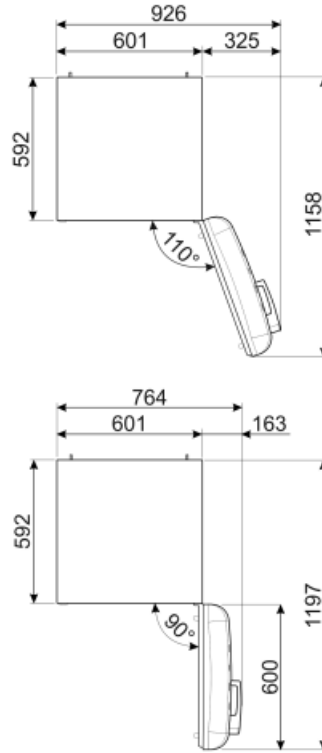
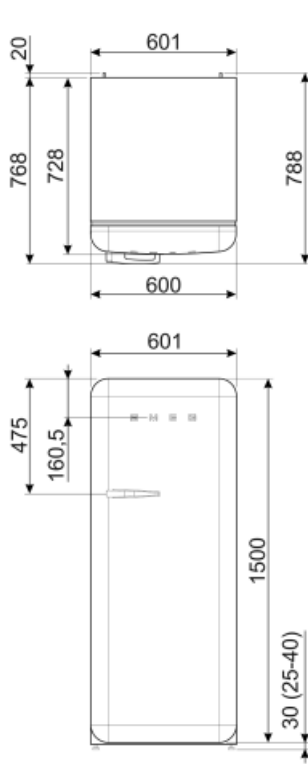

Alternative products



FAB28RDTP5

Hinge position: Right
Taupe



FAB28LPK5

Hinge position: Left
Pink



FAB28RDBLV5

Hinge position: Right
Decorated / Special



FAB28RDRB5

Hinge position: Right
Ruby Red



FAB28LBL5

Hinge position: Left
Black



FAB28LSV5

Hinge position: Left
Silver



FAB28RDIT5

Hinge position: Right
Decorated / Special



FAB28LOR5

Hinge position: Left
Orange



FAB28RCR5

Hinge position: Right
Cream



FAB28RRD5

Hinge position: Right
Red



FAB28RPB5

Hinge position: Right
Pastel blue



FAB28RPG5

Hinge position: Right
Pastel green



FAB28RYW5

Hinge position: Right
Yellow



FAB28LRD5

Hinge position: Left
Red



FAB28LPB5

Hinge position: Left
Pastel blue



FAB28LPG5

Hinge position: Left
Pastel green



FAB28RBE5

Hinge position: Right
Blue



FAB28RDUJ5

Hinge position: Right
Decorated / Special



FAB28LCR5

Hinge position: Left
Cream



FAB28RDMM5

Hinge position: Right
Decorated / Special



FAB28RWH5

Hinge position: Right
White



FAB28LYW5

Hinge position: Left
Yellow



FAB28RDEG5

Hinge position: Right
Emerald Green



FAB28LDUJ5

Hinge position: Left
Decorated / Special



FAB28RSV5

Hinge position: Right
Silver



FAB28RDBB5

Hinge position: Right
Decorated / Special



FAB28ROR5

Hinge position: Right
Orange



FAB28RBL5

Hinge position: Right
Black



FAB28RLI5

Hinge position: Right
Lime green



FAB28RPK5











Hinge position: Right
Pink



FAB28LWH5

Hinge position: Left
White

Symbols glossary (TT)

- | | | | |
|----------------------------------------------------------------------------------|--------------------------------------------------------------------------------------------------------------------------------------------|-----------------------------------------------------------------------------------|----------------------------------------------------------------------------------------------------------------------------------------------------------|
|  | 4 stars freezing compartment for better food preservation. |  | A+++: Appliances with this symbol can reduce energy consumption by a further 30% from the standard A energy rating. |
|  | The automatic defrost system works by automatically defrosting at regular intervals eliminating the need to defrost altogether. |  | Antibacterial treatment: antibacterial treatment to ensure better hygiene |
|  | Ventilated: Forced distribution of cold air in the refrigerator compartment, which allows even temperature distribution within the fridge. |  | LED interior lighting: is a more energy efficient and long lasting way of illuminating the interior of the appliance. |
|  | Life Plus 0°C: The temperature in the Lifeplus compartments is kept at 0°C, which preserves fresh meat and fish longer. |  | Smeg's evolution towards more intelligent and eco-friendly models has led to the choice of Inverter technology, which significantly reduces consumption. |
|  | Air plus: keeps food fresher for longer. |  | Energy efficiency class D |